



# IM18-05BUS-ZU0

IM AC

INDUCTIVE PROXIMITY SENSORS

**SICK**  
Sensor Intelligence.



Illustration may differ



### Ordering information

Type	Part no.
IM18-05BUS-ZU0	7902122

**Included in delivery:** BEF-MU-M18 (1)

Other models and accessories → [www.sick.com/IM\\_AC](http://www.sick.com/IM_AC)

### Detailed technical data

#### Features

<b>Housing</b>	Cylindrical thread design
<b>Housing</b>	Standard
<b>Thread size</b>	M18 x 1
<b>Diameter</b>	Ø 18 mm
<b>Sensing range <math>S_n</math></b>	5 mm
<b>Safe sensing range <math>S_a</math></b>	4.05 mm
<b>Installation type</b>	Flush
<b>Switching frequency</b>	25 Hz <sup>1)</sup> 100 Hz <sup>2)</sup>
<b>Connection type</b>	Cable, 2-wire, 2 m
<b>Output function</b>	NO
<b>Electrical wiring</b>	AC/DC 2-wire
<b>Enclosure rating</b>	IP67 <sup>3)</sup>

<sup>1)</sup> AC.

<sup>2)</sup> DC.

<sup>3)</sup> According to EN 60529.

#### Mechanics/electronics

<b>Supply voltage</b>	20 V AC/DC ... 250 V AC/DC
<b>Voltage drop</b>	≤ 6.5 V AC, ≤ 6 V DC
<b>Time delay before availability</b>	≤ 8 ms

<sup>1)</sup>  $U_b$  and  $T_a$  constant.

<sup>2)</sup> Of  $S_r$ .

<sup>3)</sup> Repeatability ( $T_a$  not constant).

<sup>4)</sup> AC (+50 °C).

<sup>5)</sup> AC (+80 °C).

<sup>6)</sup> DC.

<sup>7)</sup> 20 ms / 0.5 Hz.

<sup>8)</sup> Miniature fuse to IEC 60217-2 Sheet 1, ≤ 2 A (quick-blow).

<sup>9)</sup> Control of small electromagnetic loads with holding currents < 200 mA.

<sup>10)</sup> Control of solenoids.

<b>Hysteresis</b>	1 % ... 15 %
<b>Reproducibility</b>	≤ 10 % <sup>1) 2) 3)</sup>
<b>Temperature drift (of S<sub>r</sub>)</b>	± 10 %
<b>EMC</b>	As per EN 55011, class B As per EN 55011, class B
<b>Continuous current I<sub>a</sub></b>	≤ 350 mA <sup>4)</sup> ≤ 250 mA <sup>5)</sup> ≤ 100 mA <sup>6)</sup>
<b>Off-state current</b>	≤ 2.5 mA (AC 250 V) ≤ 1.3 mA (AC 110 V) ≤ 0.8 mA (DC 24 V)
<b>Minimum load current</b>	≥ 5 mA
<b>Short-time withstand current</b>	2.2 A <sup>7)</sup>
<b>Cable material</b>	PUR
<b>Conductor size</b>	0.5 mm <sup>2</sup>
<b>Short-circuit protection</b>	_ <sup>8)</sup>
<b>Power-up pulse protection</b>	✓
<b>Shock and vibration resistance</b>	30 g, 11 ms / 10 ... 55 Hz, 1 mm
<b>Ambient operating temperature</b>	-25 °C ... +80 °C
<b>Housing material</b>	Brass, nickel-plated
<b>Sensing face material</b>	Plastic, PBT
<b>Housing length</b>	80 mm
<b>Thread length</b>	58 mm
<b>Tightening torque, max.</b>	≤ 35 Nm
<b>Items supplied</b>	Mounting nut, brass, nickel-plated (2x)
<b>Protection class</b>	II
<b>Rated insulation voltage U<sub>i</sub></b>	250 V AC
<b>Usage category</b>	AC-140 <sup>9)</sup> DC-13 <sup>10)</sup>
<b>Contamination rating</b>	3
<b>Rated impulse withstand voltage</b>	4 kV

<sup>1)</sup> U<sub>b</sub> and T<sub>a</sub> constant.

<sup>2)</sup> Of S<sub>r</sub>.

<sup>3)</sup> Repeatability (T<sub>a</sub> not constant).

<sup>4)</sup> AC (+50 °C).

<sup>5)</sup> AC (+80 °C).

<sup>6)</sup> DC.

<sup>7)</sup> 20 ms / 0.5 Hz.

<sup>8)</sup> Miniature fuse to IEC 60217-2 Sheet 1, ≤ 2 A (quick-blow).

<sup>9)</sup> Control of small electromagnetic loads with holding currents < 200 mA.

<sup>10)</sup> Control of solenoids.

## Reduction factors

<b>Note</b>	The values are reference values which may vary
<b>Stainless steel (V2A, 304)</b>	Approx. 0.8
<b>Aluminum (Al)</b>	Approx. 0.45

<b>Copper (Cu)</b>	Approx. 0.4
--------------------	-------------

Installation note

Remark	Associated graphic see "Installation"
<b>A</b>	0 mm
<b>B</b>	18 mm
<b>C</b>	18 mm
<b>D</b>	15 mm
<b>E</b>	0 mm
<b>F</b>	40 mm

Classifications

<b>ECl@ss 5.0</b>	27270101
<b>ECl@ss 5.1.4</b>	27270101
<b>ECl@ss 6.0</b>	27270101
<b>ECl@ss 6.2</b>	27270101
<b>ECl@ss 7.0</b>	27270101
<b>ECl@ss 8.0</b>	27270101
<b>ECl@ss 8.1</b>	27270101
<b>ECl@ss 9.0</b>	27270101
<b>ECl@ss 10.0</b>	27270101
<b>ECl@ss 11.0</b>	27270101
<b>ETIM 5.0</b>	EC002714
<b>ETIM 6.0</b>	EC002714
<b>ETIM 7.0</b>	EC002714
<b>ETIM 8.0</b>	EC002714
<b>UNSPSC 16.0901</b>	39122230

Installation note

Flush installation

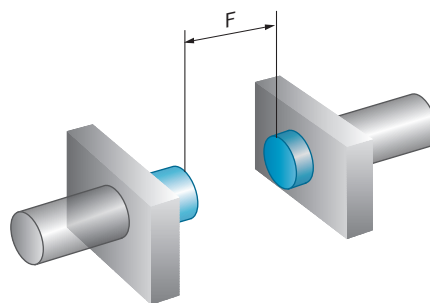
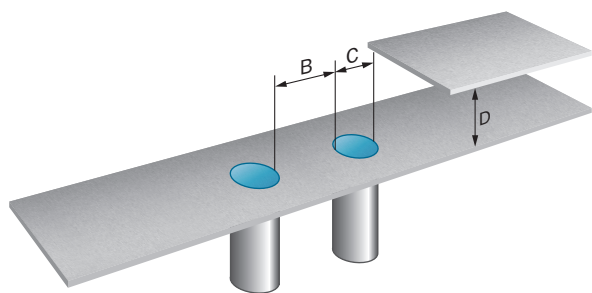

## Connection diagram

Cd-020

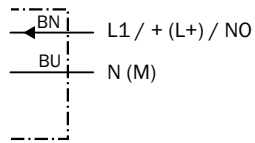

Miniature fuse to IEC60127-2  
sheet 1,  $\leq 2$  A (fast acting)

## Dimensional drawing (Dimensions in mm (inch))

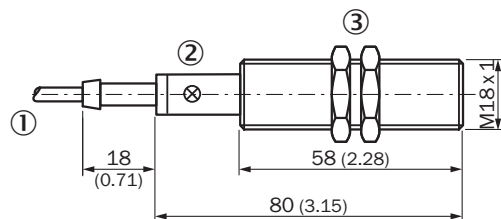

IM18, AC/DC 2-wire, cable, flush



- ① Connection
- ② Display LED
- ③ Fastening nuts (2x); width across 24, metal

## Recommended accessories

Other models and accessories → [www.sick.com/IM\\_AC](http://www.sick.com/IM_AC)

	Brief description	Type	Part no.
<b>Mounting brackets and plates</b>			
	Mounting plate for M18 sensors, steel, zinc coated, without mounting hardware	BEF-WG-M18	5321870
	Mounting bracket for M18 sensors, steel, zinc coated, without mounting hardware	BEF-WN-M18	5308446
<b>Terminal and alignment brackets</b>			
	Clamping block for round sensors M18, without fixed stop, plastic (PA12), glass-fiber reinforced, mounting hardware included	BEF-KH-M18	2051481

## SICK AT A GLANCE

SICK is one of the leading manufacturers of intelligent sensors and sensor solutions for industrial applications. A unique range of products and services creates the perfect basis for controlling processes securely and efficiently, protecting individuals from accidents and preventing damage to the environment.

We have extensive experience in a wide range of industries and understand their processes and requirements. With intelligent sensors, we can deliver exactly what our customers need. In application centers in Europe, Asia and North America, system solutions are tested and optimized in accordance with customer specifications. All this makes us a reliable supplier and development partner.

Comprehensive services complete our offering: SICK LifeTime Services provide support throughout the machine life cycle and ensure safety and productivity.

For us, that is “Sensor Intelligence.”

## WORLDWIDE PRESENCE:

Contacts and other locations –[www.sick.com](http://www.sick.com)