



DT35-B15251

Filling level monitoring

APPLICATION SOFTWARE

SICK
Sensor Intelligence.



Ordering information

Type	Part no.
DT35-B15251	1057652

Other models and accessories → www.sick.com/Filling_level_monitoring



Detailed technical data

Mechanics/electronics

Supply voltage V_s	DC 12 V ... 30 V ^{1) 2)}
Ripple	$\leq 5 V_{pp}$ ³⁾
Power consumption	$\leq 1.7 W$ ⁴⁾
Initialization time	≤ 500 ms
Warm-up time	≤ 20 min
Housing material	Plastic (ABS/PC)
Window material	Plastic (PMMA)
Connection type	Male connector, M12, 5-pin
Indication	LEDs
Weight	65 g
Dimensions (W x H x D)	32 mm x 58.67 mm x 42.7 mm
Enclosure rating	IP65 IP67
Protection class	III

¹⁾ Limit values, reverse-polarity protected, operation in short-circuit protected network: max. 8 A.

²⁾ When using IO-Link output $V_s > 18$ V. When using analog voltage output $V_s > 13$ V.

³⁾ May not fall short of or exceed V_s tolerances.

⁴⁾ Without load, at +20 °C.

Safety-related parameters

MTTF_D	101 years
-------------------------	-----------

Performance

Measurement range min ... max:	50 mm ... 12,000 mm, 90% remission factor ^{1) 2)} 50 mm ... 5,300 mm, 18 % remission 50 mm ... 3,100 mm, 6% remission factor
Target	Natural objects
Resolution	0.1 mm
Repeatability	≥ 0.5 mm ^{2) 3) 4)}
Accuracy	Typ. ± 10 mm ⁴⁾
Response time	2.5 ms ... 96.5 ms, 2.5 ms / 6.5 ms / 12.5 ms / 24.5 ms / 96.5 ms ^{5) 6)}
Switching frequency	333 Hz / 100 Hz / 50 Hz / 25 Hz / 6 Hz ^{5) 6)}
Output time	1 ms ... 32 ms, 1 ms/2 ms/4 ms/8 ms/32 ms ^{5) 7)}
Light source	Laser, red ⁸⁾ visible red light
Laser class	2 (IEC 60825-1:2014, EN 60825-1:2014)
Typ. light spot size (distance)	15 mm x 15 mm (at 2 m)
Additional function	Set speed: Super Fast ... Super Slow, teach-in of analog output and invertible analog output, Output Q ₂ adaptable: Current output / Voltage output / Digital output, Switching mode: Distance to Object (DtO) / switching window / object between sensor and background (ObSB), teach-in of digital output and digital output invertible, Multifunctional input: laser off / external teach / deactivated, reset to factory default
Average laser service life (at 25 °C)	100,000 h

¹⁾ For speed setting Slow.

²⁾ See repeatability characteristic lines.

³⁾ Equivalent to 1 σ .

⁴⁾ 6% ... 90% remission factor.

⁵⁾ Depending on the set speed: Super Fast ... Super Slow.

⁶⁾ Lateral entry of the object into the measuring range.

⁷⁾ Continuous change of distance in measuring range.

⁸⁾ Wavelength: 658 nm; max. output: 250 mW; pulse duration: 3 ns; duty cycle: 1/250.

Interfaces

IO-Link	✓, IO-Link V1.1
Function	Process data, parameterization, diagnosis
Data transmission rate	38.4 kbit/s
Digital output	
Number	1 ... 2 ^{1) 2)}
Type	Push-pull: PNP/NPN
Function	Output Q ₂ adaptable: Current output / Voltage output / Digital output
Maximum output current I _A	≤ 100 mA
Analog output	
Number	1
Type	Current output / voltage output
Function	Output Q ₂ adaptable: Current output / Voltage output / Digital output

¹⁾ Output Q short-circuit protected.

²⁾ Voltage drop < 3 V.

³⁾ Response time ≤ 60 ms.

⁴⁾ Configurable via IO-Link.

	Current	4 mA ... 20 mA, $\leq 450 \Omega$
	Voltage	0 V ... 10 V, $\geq 50,000 \Omega$
	Resolution	12 bit
Multifunctional input (MF)		$1 \times$ ³⁾
Hysteresis		0 mm ... 11,950 mm ⁴⁾

¹⁾ Output Q short-circuit protected.

²⁾ Voltage drop < 3 V.

³⁾ Response time ≤ 60 ms.

⁴⁾ Configurable via IO-Link.

Ambient data

Ambient temperature, operation	-30 °C ... +55 °C, $U_v \leq 24$ V
Ambient temperature, storage	-40 °C ... +75 °C
Max. rel. humidity (not condensing)	≤ 95 %
Vibration resistance	EN 60068-2-6, EN 60068-2-64
Shock resistance	EN 60068-2-27

Classifications

ECLASS 5.0	27270801
ECLASS 5.1.4	27270801
ECLASS 6.0	27270801
ECLASS 6.2	27270801
ECLASS 7.0	27270801
ECLASS 8.0	27270801
ECLASS 8.1	27270801
ECLASS 9.0	27270801
ECLASS 10.0	27270801
ECLASS 11.0	27270801
ECLASS 12.0	27270916
ETIM 5.0	EC001825
ETIM 6.0	EC001825
ETIM 7.0	EC001825
ETIM 8.0	EC001825
UNSPSC 16.0901	41111613

Dimensional drawing (Dimensions in mm (inch))

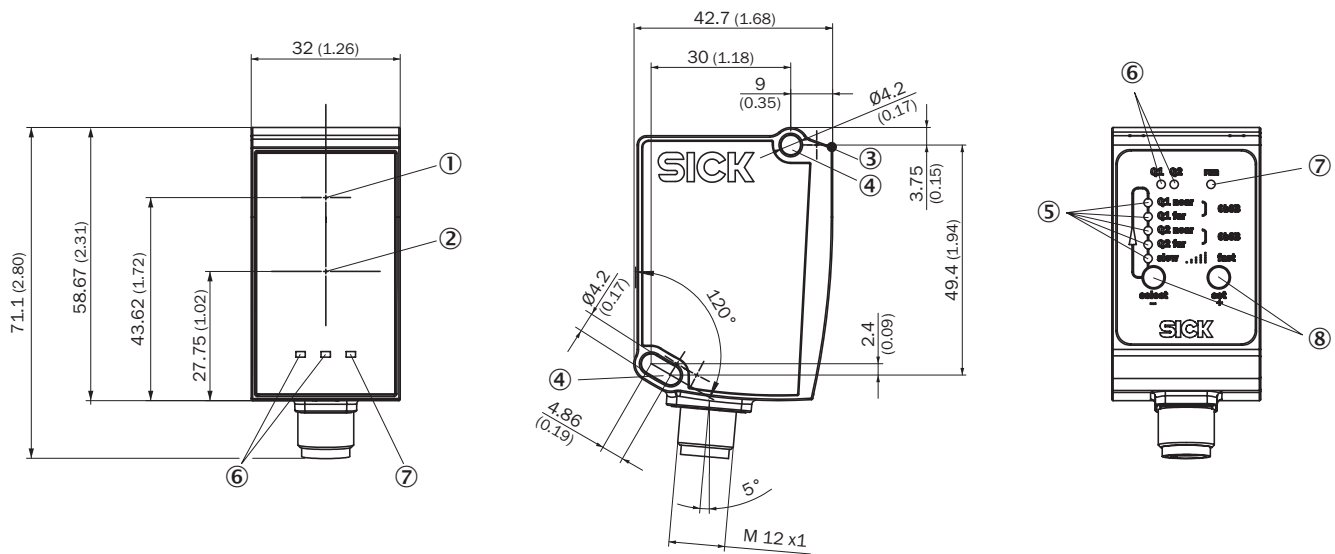

- ① Optical axis, sender
- ② Optical axis, receiver
- ③ Zero level
- ④ Mounting hole M4
- ⑤ Status indicator output Qa/Q2
- ⑥ Status LEDs output Q1
- ⑦ Operating indicator
- ⑧ Control elements

Connection type

Male connector M12, 5-pin

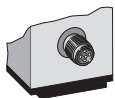

Connection diagram

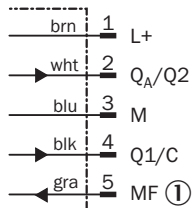

- ① Multifunctional input (MF)

Repeatability

Characteristic curve 1) Super Slow

Super Slow

Repeatability in mm (inch)

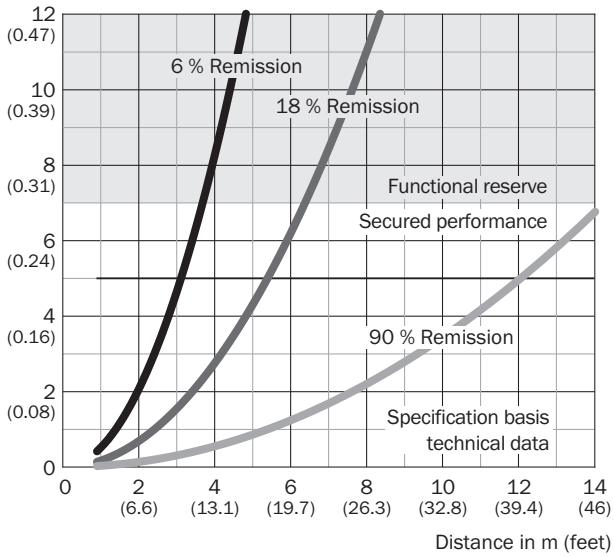

Characteristic curve 5) Super Fast

Super Fast

Repeatability in mm (inch)

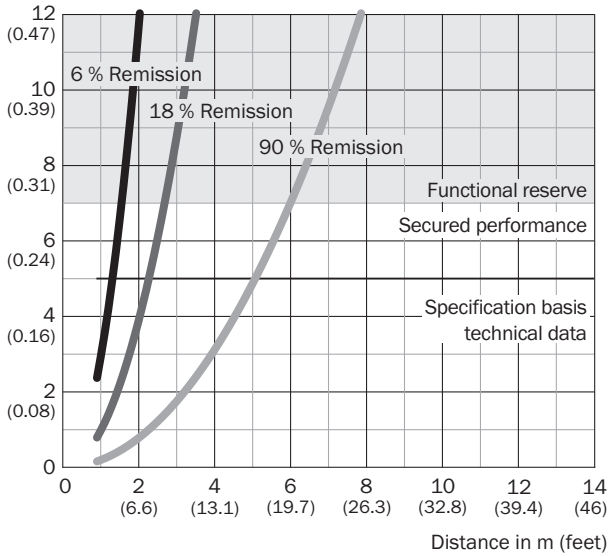

Characteristic curve 2) Slow

Slow

Repeatability in mm (inch)

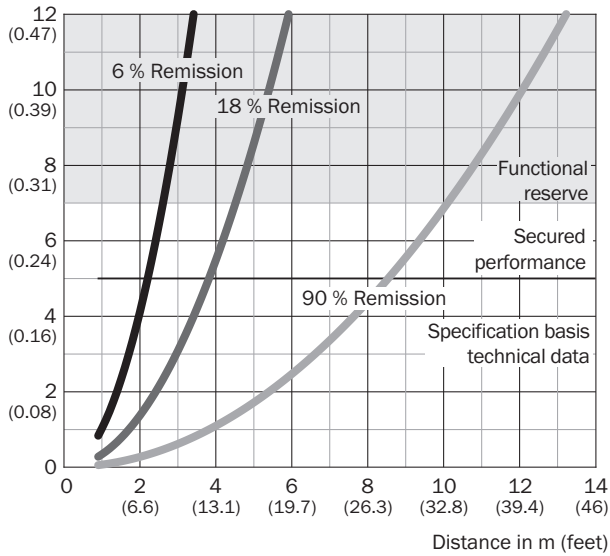

Characteristic curve 3) Medium

Medium

Repeatability in mm (inch)

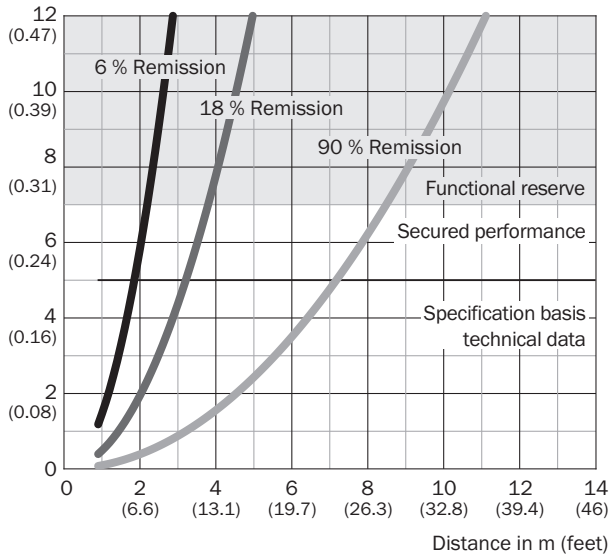

Characteristic curve 4) Fast





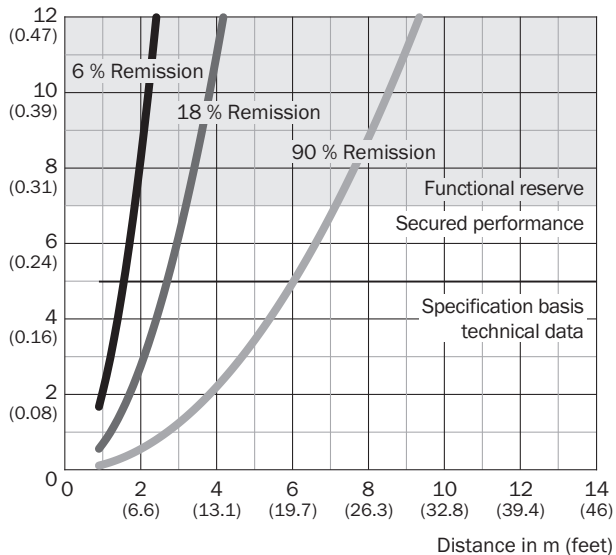

Fast

Repeatability in mm (inch)



Recommended accessories

Other models and accessories → www.sick.com/Filling_level_monitoring

	Brief description	Type	Part no.
Universal bar clamp systems			
	Plate N02 for universal clamp bracket, Zinc plated steel (sheet), Zinc die cast (clamping bracket), Universal clamp (5322626), mounting hardware	BEF-KHS-N02	2051608
Mounting brackets and plates			
	Mounting bracket: horizontal sending axis for ceiling or floor installation or vertical sending axis for wall installation, steel, zinc coated, incl. mounting material, steel, zinc coated, mounting hardware for the sensor included	BEF-WN-DX35	2069592
Plug connectors and cables			
	Head A: female connector, M12, 5-pin, straight, A-coded Head B: Flying leads Cable: Sensor/actuator cable, PVC, unshielded, 2 m	YF2A15-020VB5XLEAX	2096239
	Head A: female connector, M12, 5-pin, angled, A-coded Head B: Flying leads Cable: Sensor/actuator cable, PVC, unshielded, 2 m	YG2A15-020VB5XLEAX	2096215
	Head A: female connector, M12, 5-pin, straight, A-coded Head B: male connector, M12, 5-pin, straight, A-coded Cable: Sensor/actuator cable, PUR, halogen-free, unshielded, 2 m	YF2A15-020UB5M2A15	2096009
Terminal and alignment brackets			
	Alignment unit, steel, zinc coated, mounting hardware for the sensor included	BEF-AH-DX50	2048397

SICK AT A GLANCE

SICK is one of the leading manufacturers of intelligent sensors and sensor solutions for industrial applications. A unique range of products and services creates the perfect basis for controlling processes securely and efficiently, protecting individuals from accidents and preventing damage to the environment.

We have extensive experience in a wide range of industries and understand their processes and requirements. With intelligent sensors, we can deliver exactly what our customers need. In application centers in Europe, Asia and North America, system solutions are tested and optimized in accordance with customer specifications. All this makes us a reliable supplier and development partner.

Comprehensive services complete our offering: SICK LifeTime Services provide support throughout the machine life cycle and ensure safety and productivity.

For us, that is “Sensor Intelligence.”

WORLDWIDE PRESENCE:

Contacts and other locations –www.sick.com