

# BTF08-P1HM0241

HighLine

WIRE DRAW ENCODERS

**SICK**  
Sensor Intelligence.

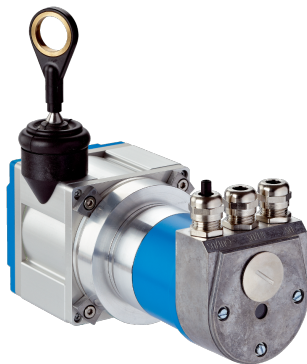

### Ordering information

Type	Part no.
BTF08-P1HM0241	1034305

**Included in delivery:** ATM60-P1H13X13 (1), MRA-F080-102D2 (1)

Bus adapter not included with delivery

Product is supplied fully assembled. See individual components for further technical data

A succession solution with the same wire draw mechanism and a functionally largely compatible encoder can be found at the link below. our sales department will be happy to assist if you have any further questions about selecting a suitable succession solution.

Other models and accessories → [www.sick.com/HighLine](http://www.sick.com/HighLine)



### Detailed technical data

#### Performance

<b>Measurement range</b>	0 m ... 2 m
<b>Encoder</b>	Absolute encoders
<b>Resolution (wire draw + encoder)</b>	0.02 mm <sup>1) 2)</sup>
<b>Repeatability</b>	≤ 1 mm <sup>3)</sup>
<b>Linearity</b>	≤ ± 2 mm <sup>3)</sup>
<b>Hysteresis</b>	≤ 2 mm <sup>3)</sup>

<sup>1)</sup> The values shown have been rounded.

<sup>2)</sup> Example calculation based on the BTF08 with PROFINET: 200 mm (wire draw length per revolution - see Mechanical data): 262,144 (number of steps per revolution) = 0.001 mm (resolution of wire draw + encoder combination).

<sup>3)</sup> Value applies to wire draw mechanism.

#### Interfaces

<b>Communication interface</b>	PROFIBUS DP
<b>Programmable/configurable</b>	✓

#### Electrical data

<b>Connection type</b>	Bus adapter for PROFIBUS <sup>1)</sup>
<b>Supply voltage</b>	10 V ... 32 V
<b>Power consumption</b>	≤ 2 W (without load)
<b>MTTFd: mean time to dangerous failure</b>	150 years (EN ISO 13849-1) <sup>2)</sup>

<sup>1)</sup> Order bus adapter separately.

<sup>2)</sup> This product is a standard product and does not constitute a safety component as defined in the Machinery Directive. Calculation based on nominal load of components, average ambient temperature 40 °C, frequency of use 8760 h/a. All electronic failures are considered hazardous. For more information, see document no. 8015532.

## Mechanical data

<b>Weight</b>	1.89 kg
<b>Measuring wire material</b>	Highly flexible stranded steel 1,4401 stainless steel V4A
<b>Measuring wire diameter</b>	1.35 mm
<b>Weight (measuring wire)</b>	7.1 g/m
<b>Housing material, wire draw mechanism</b>	Aluminum (anodized), aluminum die cast (nickel-plated)
<b>Spring return force</b>	6 N ... 14 N <sup>1)</sup>
<b>Length of wire pulled out per revolution</b>	200 mm
<b>Life of wire draw mechanism</b>	Typ. 1,000,000 cycles <sup>2) 3)</sup>
<b>Actual wire draw length</b>	2.2 m
<b>Wire acceleration</b>	40 m/s <sup>2</sup>
<b>Operating speed</b>	8 m/s
<b>Mounted encoder</b>	ATM60 PROFIBUS, ATM60-P1H13X13, 1030014
<b>Mounted mechanic</b>	MRA-F080-102D2, 6028625

<sup>1)</sup> These values were measured at an ambient temperature of 25 °C. There may be variations at other temperatures.

<sup>2)</sup> Average values, which depend on the application.

<sup>3)</sup> The service life depends on the type of load. This is influenced by environmental conditions, the installation location, the measuring range in use, the traversing speed, and acceleration.

## Ambient data

<b>EMC</b>	According to EN 61000-6-2 and EN 61000-6-3
<b>Enclosure rating</b>	IP64, mounted mechanic
<b>Operating temperature range</b>	-20 °C ... +70 °C

## Classifications

<b>ECLASS 5.0</b>	27270590
<b>ECLASS 5.1.4</b>	27270590
<b>ECLASS 6.0</b>	27270590
<b>ECLASS 6.2</b>	27270590
<b>ECLASS 7.0</b>	27270590
<b>ECLASS 8.0</b>	27270590
<b>ECLASS 8.1</b>	27270590
<b>ECLASS 9.0</b>	27270590
<b>ECLASS 10.0</b>	27270613
<b>ECLASS 11.0</b>	27270503
<b>ECLASS 12.0</b>	27270503
<b>ETIM 5.0</b>	EC001486
<b>ETIM 6.0</b>	EC001486
<b>ETIM 7.0</b>	EC001486
<b>ETIM 8.0</b>	EC001486
<b>UNSPSC 16.0901</b>	41112113

### Dimensional drawing (Dimensions in mm (inch))

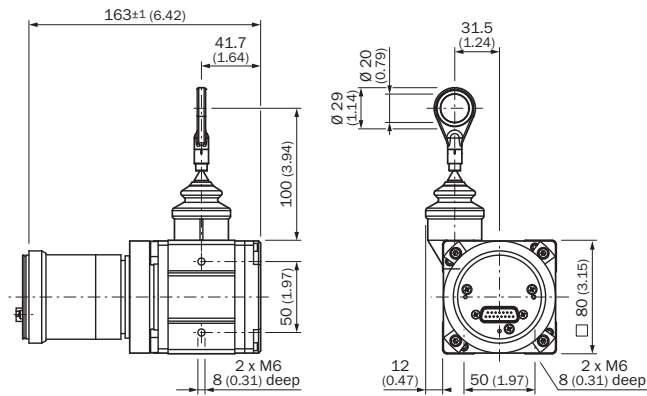

### PIN assignment

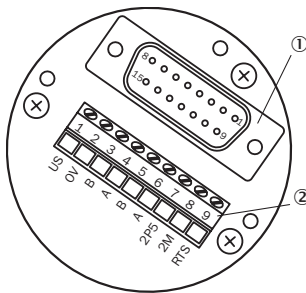

- ① Internal plug connector to encoder
- ② External connection to the bus

**Encoders with a PROFIBUS connection adapter have screw connections (metric/PG) for connecting the bus and supply cables. The bus adapter from the complete device is screwed on to connect the cables. The adjacent figure shows the pin assignment within the bus adapter.**









Terminal strip	Connector 4-pin	Connector 5-pin	Female connector 5 pin	Signal	Explanation
1	1	-	-	U <sub>S</sub> (24 V)	Operating voltage 10 ... 32 V
2	3	-	-	0 V (GND)	Ground (0 V)
3	-	-	4	B	B-cable PROFIBUS DP (out)
4	-	-	2	A	A-cable PROFIBUS DP (out)
5	-	4	-	B	B-cable PROFIBUS DP (out)
6	-	2	-	A	A-cable PROFIBUS DP (out)
7	-	-	1	2P5 1)	+ 5 V (potential free)
8	-	-	3	2M 1)	0 V (potential free)
-	2	1	-	N.C.	-
-	4	3	-	N.C.	-

Encoders with a PROFIBUS connection adapter have screw connections (metric/PG) for connecting the bus and supply cables. The bus adapter from the complete device is screwed on to connect the cables. The adjacent figure shows the pin assignment within the bus adapter.

-	-	5	5	Screen	Housing potential
1)					
Use for external bus terminations or to supply the sender/receiver with a optical fiber transmission					

### Recommended accessories

Other models and accessories → [www.sick.com/HighLine](http://www.sick.com/HighLine)

	Brief description	Type	Part no.
<b>Bus adapter</b>			
	KR3 bus adapter, 3 x PG	AD-ATM60-KA3PR	2029225
	SR3 bus adapter, 3 x M12, 5-pin	AD-ATM60-SR3PR	2031985
<b>Wire draw mechanism</b>			
	HighLine wire draw mechanism for servo flange with 6 mm shaft, measuring range 0 m ... 2 m	MRA-F080-102D2	6028625
<b>Flanges</b>			
	Flange adapter for HighLine wire draw mechanisms, adaption of face mount flange with centering hub 20 mm to 50 mm servo flange, Aluminum, including 3 countersunk screws M3 x 10	BEF-FA-020-050WDE	2073776
<b>Other mounting accessories</b>			
	Joint ball for later insertion in wire end ring with 20 mm diameter. The use of this joint ball enables movement in multiple levels of freedom.	Joint protection for wire rope BTF/PRF/MRA	5318683
	Compressed air attachment for MRA-F080... and MRA-F130... HighLine wire draw mechanism	MRA-F-P	6073769
	Additional brush attachment for wire draw mechanism MRA-F080 (2 m and 3 m from HighLine series)	MRA-F080-B	6045341
	Wire draw deflection pulley for wire draw mechanism MRA-F080 (2m and 3m from HighLine series)	MRA-F080-R	6028632
<b>Plug connectors and cables</b>			
	<ul style="list-style-type: none"> <li>• <b>Connection type head A:</b> Flying leads</li> <li>• <b>Connection type head B:</b> Flying leads</li> <li>• <b>Signal type:</b> PROFIBUS DP</li> <li>• <b>Cable:</b> 2-wire, PUR</li> <li>• <b>Description:</b> PROFIBUS DP, shielded</li> </ul>	LTG-2102-MW	6021355
	<ul style="list-style-type: none"> <li>• <b>Connection type head A:</b> Female connector, M12, 5-pin, straight, B-coded</li> <li>• <b>Connection type head B:</b> Flying leads</li> <li>• <b>Signal type:</b> PROFIBUS DP</li> <li>• <b>Cable:</b> 1.2 m, 2-wire, PUR, halogen-free</li> <li>• <b>Description:</b> PROFIBUS DP, twisted pair, shielded</li> <li>• <b>Connection systems:</b> Flying leads</li> <li>• <b>Application:</b> Zones with oils and lubricants</li> </ul>	DOL-1205-G12MQ	6032636

	Brief description	Type	Part no.
	<ul style="list-style-type: none"> <li>• <b>Connection type head A:</b> Female connector, M12, 4-pin, straight, A-coded</li> <li>• <b>Connection type head B:</b> Flying leads</li> <li>• <b>Signal type:</b> Sensor/actuator cable</li> <li>• <b>Cable:</b> 5 m, 4-wire, PVC</li> <li>• <b>Description:</b> Sensor/actuator cable, unshielded</li> <li>• <b>Application:</b> Zones with chemicals</li> </ul>	YF2A14-050VB3XLEAX	2096235
	<ul style="list-style-type: none"> <li>• <b>Connection type head A:</b> Female connector, M12, 2-pin, straight, B-coded</li> <li>• <b>Connection type head B:</b> Flying leads</li> <li>• <b>Signal type:</b> Fieldbus, PROFIBUS DP</li> <li>• <b>Cable:</b> 5 m, 2-wire, PUR, halogen-free</li> <li>• <b>Description:</b> Fieldbus, PROFIBUS DP, shielded</li> <li>• <b>Application:</b> Drag chain operation, Zones with oils and lubricants</li> </ul>	YF2B22-050PB1XLEAX	2121936
	<ul style="list-style-type: none"> <li>• <b>Connection type head A:</b> Female connector, M12, 2-pin, straight, B-coded</li> <li>• <b>Connection type head B:</b> Flying leads</li> <li>• <b>Signal type:</b> Fieldbus, PROFIBUS DP</li> <li>• <b>Cable:</b> 10 m, 2-wire, PUR, halogen-free</li> <li>• <b>Description:</b> Fieldbus, PROFIBUS DP, shielded</li> <li>• <b>Application:</b> Drag chain operation, Zones with oils and lubricants</li> </ul>	YF2B22-100PB1XLEAX	2106269
	<ul style="list-style-type: none"> <li>• <b>Connection type head A:</b> Female connector, M12, 2-pin, straight, B-coded</li> <li>• <b>Connection type head B:</b> Flying leads</li> <li>• <b>Signal type:</b> Fieldbus, PROFIBUS DP</li> <li>• <b>Cable:</b> 15 m, 2-wire, PUR, halogen-free</li> <li>• <b>Description:</b> Fieldbus, PROFIBUS DP, shielded</li> <li>• <b>Application:</b> Drag chain operation, Zones with oils and lubricants</li> </ul>	YF2B22-150PB1XLEAX	2106272
	<ul style="list-style-type: none"> <li>• <b>Connection type head A:</b> Female connector, M12, 2-pin, straight, B-coded</li> <li>• <b>Connection type head B:</b> Flying leads</li> <li>• <b>Signal type:</b> Fieldbus, PROFIBUS DP</li> <li>• <b>Cable:</b> 20 m, 2-wire, PUR, halogen-free</li> <li>• <b>Description:</b> Fieldbus, PROFIBUS DP, shielded</li> <li>• <b>Application:</b> Drag chain operation, Zones with oils and lubricants</li> </ul>	YF2B22-200PB1XLEAX	2106273
	<ul style="list-style-type: none"> <li>• <b>Connection type head A:</b> Male connector, M12, 2-pin, straight, B-coded</li> <li>• <b>Connection type head B:</b> Flying leads</li> <li>• <b>Signal type:</b> Fieldbus, PROFIBUS DP</li> <li>• <b>Cable:</b> 5 m, 2-wire, PUR, halogen-free</li> <li>• <b>Description:</b> Fieldbus, PROFIBUS DP, shielded</li> <li>• <b>Application:</b> Drag chain operation, Zones with oils and lubricants</li> </ul>	YM2B22-050PB1XLEAX	2106270
	<ul style="list-style-type: none"> <li>• <b>Connection type head A:</b> Male connector, M12, 2-pin, straight, B-coded</li> <li>• <b>Connection type head B:</b> Flying leads</li> <li>• <b>Signal type:</b> Fieldbus, PROFIBUS DP</li> <li>• <b>Cable:</b> 10 m, 2-wire, PUR, halogen-free</li> <li>• <b>Description:</b> Fieldbus, PROFIBUS DP, shielded</li> <li>• <b>Application:</b> Drag chain operation, Zones with oils and lubricants</li> </ul>	YM2B22-100PB1XLEAX	2106271
	<ul style="list-style-type: none"> <li>• <b>Connection type head A:</b> Male connector, M12, 2-pin, straight, B-coded</li> <li>• <b>Connection type head B:</b> Flying leads</li> <li>• <b>Signal type:</b> Fieldbus, PROFIBUS DP</li> <li>• <b>Cable:</b> 15 m, 2-wire, PUR, halogen-free</li> <li>• <b>Description:</b> Fieldbus, PROFIBUS DP, shielded</li> <li>• <b>Application:</b> Drag chain operation, Zones with oils and lubricants</li> </ul>	YM2B22-150PB1XLEAX	2106276
	<ul style="list-style-type: none"> <li>• <b>Connection type head A:</b> Female connector, M12, 4-pin, straight</li> <li>• <b>Description:</b> Unshielded, Head A: female connector, M12, 4-pin, straight, unshielded, for power supply, for cable diameter 4 mm ... 6 mm Head B: -</li> <li>• <b>Connection systems:</b> Screw-type terminals</li> <li>• <b>Permitted cross-section:</b> ≤ 0.75 mm<sup>2</sup></li> </ul>	DOS-1204-G	6007302
	<ul style="list-style-type: none"> <li>• <b>Connection type head A:</b> Female connector, M12, 5-pin, straight, B-coded</li> <li>• <b>Signal type:</b> PROFIBUS DP</li> <li>• <b>Description:</b> PROFIBUS DP, shielded, Head A: M12 female connector, 5-pin, straight, B-coded, PROFIBUS DP, shielded, for cable diameter 4 mm ... 9 mm Head B: -</li> <li>• <b>Connection systems:</b> Screw-type terminals</li> <li>• <b>Permitted cross-section:</b> ≤ 0.75 mm<sup>2</sup></li> </ul>	DOS-1205-GQ	6021353

	Brief description	Type	Part no.
	<ul style="list-style-type: none"> <li>• <b>Connection type head A:</b> Male connector, M12, 5-pin, straight, B-coded</li> <li>• <b>Signal type:</b> PROFIBUS DP</li> <li>• <b>Description:</b> PROFIBUS DP, shielded, Head A: male connector, M12, 5-pin, straight, B coded, shielded, for cable diameter 4 mm ... 9 mm Head B: -</li> <li>• <b>Connection systems:</b> Screw-type terminals</li> <li>• <b>Permitted cross-section:</b> ≤ 0.75 mm<sup>2</sup></li> </ul>	STE-1205-GQ	6021354

## SICK AT A GLANCE

SICK is one of the leading manufacturers of intelligent sensors and sensor solutions for industrial applications. A unique range of products and services creates the perfect basis for controlling processes securely and efficiently, protecting individuals from accidents and preventing damage to the environment.

We have extensive experience in a wide range of industries and understand their processes and requirements. With intelligent sensors, we can deliver exactly what our customers need. In application centers in Europe, Asia and North America, system solutions are tested and optimized in accordance with customer specifications. All this makes us a reliable supplier and development partner.

Comprehensive services complete our offering: SICK LifeTime Services provide support throughout the machine life cycle and ensure safety and productivity.

For us, that is “Sensor Intelligence.”

## WORLDWIDE PRESENCE:

Contacts and other locations –[www.sick.com](http://www.sick.com)